

DuraRoll
Steel Roller Garage Door



Great to come home to!

www.garagedoorsystems.co.uk



Brilliant things at a glance!



Feature File



Reliable, durable and attractive.
The perfect roller door?



Extra Easy 

Convenient
Vertical opening for maximum use of your garage and driveway.

Security Guard 

Enhanced Security
Highly pick resistant steel lock barrel mechanism as standard on each DuraRoll steel roller door.

Smart Touch 

Automation
All single skin roller doors including the mini can easily be automated with the LiftMaster™ LM750 EVGB side mount motor.

Smart Touch 

Smart Phone Control
Smart phone control with LiftMaster™ MyQ® option.



Weather Shield 

Bottom Seal
Robust rubber bottom seal secured in a corrosion resistant aluminium profile.

Safety Sure 

Safety first
Independently tested for safety and CE marked for total peace of mind.

Welcome home!

*At your
service!*



Our Promise

As a manufacturer & supplier we are determined to build on our established reputation as one of the industry leaders for customer care and quality products. We will continue to grow by exceeding our customers' expectations at every opportunity and further establish ourselves as a reliable partner for the future.

**Peter Doherty, Managing Director,
Garage Door Systems Limited**

At Garage Door Systems we know that our reputation is built upon the trust we inspire in every customer.

We want you to choose a Garage Door Systems garage door because you have the confidence in us as a company to know that:

- The products we make are well designed, built to last and are a pleasure to use every day. ✓
- All the garage doors we make come with our satisfaction promise and carry the performance and safety assurance of a CE mark. ✓
- Every door is made to order and made to measure for the ideal fit. ✓

We've been making garage doors since 1994 and our reputation is built on the half a million + of our garage doors and openers that have become part of homes throughout the UK & Ireland.

Quality, safety and security are held as our most important values.

It's essential that your new garage door is made to last, operates safely and provides a good level of security. Garage Door Systems' Design Engineers have created garage doors that lead the industry for their use of high grade materials and design features that ensure operation is not only safe but easy and reliable, day-in, day-out.

Quality extends to the service we provide to support our products and the team at Garage Door Systems is committed to making sure every contact is handled with courtesy and professionalism.



www.garagedoorsystems.co.uk

Feature File

Feature File



Made to measure



Exceptional performance and build quality

The DuraRoll single skin roller door with its patented broad profile design offers exceptional performance combined with enhanced security and colour choice. Every door is made to measure for a perfect fit.

Security as standard

- Made with 0.5 gauge thick steel for extra strength.
- Manual option has solid lock rods and a metal lock body making it extremely secure.
- Automated option is held closed by positive force and includes Evolution technology for secure operation & peace of mind.

Security Guard

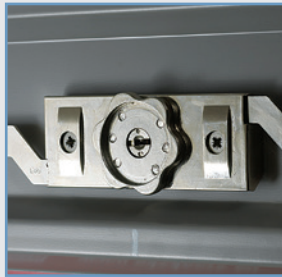

Draught resistance

- Bottom weather seal that compresses against the floor to help keep out draughts and debris.
- Guide tracks fit behind the garage opening and enclose the door curtain to help reduce draughts.

Weather Shield

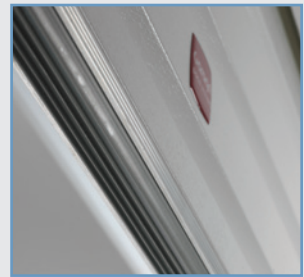

Safety built-in

- CE marked for safety and tested to the latest European safety legislation.
- Force sensing automation stops and reverses on detection of an obstruction.
- Lifting spring is out of reach within the door barrel.

Safety Sure



Remote control

- Available with the world's number one remote control motor from LiftMaster™.
- LED courtesy light.
- Reliable and secure - holds the door closed by positive force and includes Evolution technology for secure operation & peace of mind.

Smart Touch



Extra space!

- Fitted behind the garage opening, it adds up to six inches of drive through width.
- Vertical travel means the door has no "kick-out" and enables you to park right up to the garage door inside and out.
- Spring assisted opening means manual opening is smooth and easy.

Space Saving



Robust quality

- High grade materials and durable low maintenance finishes.
- Deeper guide tracks and 0.5 gauge steel door curtain add strength and better resistance to minor everyday knocks and bumps.

Built to Last



Stylish

- Broad profile ribs are patented and unique to Garage Door Systems. Deeper ribs suit a domestic setting better than narrow 'industrial' rib designs.
- Great choice of low maintenance, wipe-clean Plastisol colours.

Designer Style

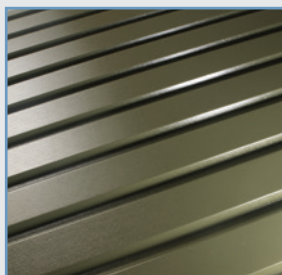

Convenience - park right up!

- Space saving - As the curtain rolls neatly up behind your garage lintel there are no tracks inside your garage providing additional space and "park right up" convenience.

Space Saving





Juniper Green Plastisol Finish

Light, smooth and quiet

Every detail considered and chosen for performance and durability...



Extra Easy

Lock Handle

All DuraRoll steel roller doors are supplied with a handle and lock as standard.



Security Guard

Enhanced Security

Highly pick resistant steel lock barrel mechanism as standard on each DuraRoll steel roller door.



Safety Sure

Photo Eyes

Non-contact photo eyes are an optional safety feature. Once the infrared beam is broken, the door automatically reverses providing additional safety.



Weather Shield

Bottom Seal
Robust rubber bottom seal secured in a corrosion resistant aluminium profile.



Feature
File



DuraRoll
Steel Roller Garage Door



Smart
Touch



Automation
All single skin roller doors including the mini can easily be automated with the LiftMaster™ LM750 EVGB side mount motor.

Built to
Last



Welded Brackets
DuraRoll support brackets are substantially stronger than other doors - thicker steel and welded joints ensure strength and a powder coat finish neatens their appearance.

Built to
Last



Steel Guides
The door curtain is protected with reinforced nyloflex webbing that ensures smooth running and is secured within full length steel guides.

Security
Guard



Lock Bars
Manual doors are held in the closed position via dual lock bars that engage within the steel guides.

Colours & finishes

Select from our varied range of durable, wipe clean colours - you're sure to find the perfect choice!



LEATHERGRAIN PLASTISOL

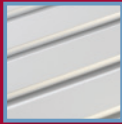

WHITE
BS 00 E 55



JUNIPER GREEN
BS 12 B 29



BURGUNDY
BS 04 D 45



BLACK
BS 00 E 53

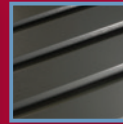

ANTHRACITE GREY
RAL 7016

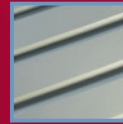

GOOSEWING GREY
BS 10 A 05

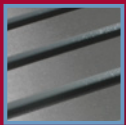

MERLIN GREY
BS 18 B 25



NAVY BLUE
RAL 5003



VANDYKE BROWN
BS 08 B 29



MUSHROOM
BS 10 B 19



OLIVE GREEN
BS 12 B 27

FOIL

PLEASE NOTE: FOIL COLOURS
ATTRACT A SURCHARGE.



GOLDEN OAK



ROSEWOOD

Colours shown are for guide purposes only and are limited by the printing process. Always request to see a finish sample for confirmation of colour. RAL numbers are provided as the nearest approximation to the colour and will not match precisely.

Black Plastisol Finish

The UK & Ireland's

No.1



Make life
EASY with a
REMOTE!

Rosewood
Foil
Finish



Steel Roller



Reliable, durable, attractive.
The perfect roller door?

The UK's & Ireland's no.1 roller garage door - DuraRoll. Its popularity is the result of 20 years of development and refinement.



Merlin Grey
Plastisol
Finish



Anthracite Grey Plastisol Finish



White
Plastisol
Finish

Widely recognised for its superior build quality and design, the DuraRoll single skin roller door, with its patented broad profile design lends itself perfectly to residential settings.

DuraRoll offers exceptional performance combined with enhanced security and a great choice of hard wearing colour finishes.



13 colour finishes!



Golden
Oak
Foil Finish

Power up with the world's No.1!

Why leave the comfort and safety of your car when you can press a button and be home and dry?!



- DuraRoll garage doors are available with the option of a LiftMaster™ remote control drive system.
- LiftMaster™ is the worldwide No.1 for garage door automation and control systems.
- The LiftMaster™ LM750 EVGB Drive Motor has a 5 year warranty.
- Every automated door must be CE marked on completion of the installation, once all safety systems have been tested for sensitivity and the door and drive checked and properly commissioned. CE marking of the completed automated door system is the law (not just the individual components such as the door and drive).
- Garage Door Systems strongly recommends that you do not fit a door and operator that does not comply with the law, and that you do not purchase any product that will not be CE marked and tested for safe operation at your home - safety first!



Now with myQ option!

Revolutionary new accessory with built-in myQ® technology that connects to the internet and allows monitoring and operating the garage door opener in or around your home or from anywhere in the world by using a smartphone or a computer. Requires myQ Kit option.



4 button Mini transmitters

Make life EASY with a REMOTE!



Wireless wall control station



Optional keypad control



Optional non-contact photo eyes

Optional myQ kit

LM750 EVGB

- LiftMaster's™ LM750 EVGB has the power and performance to open even the largest door - Max door weight 120 Kg.
- LM750 EVGB - 550 Newton.
- Two 4-Button Mini Transmitters, 868 MHz, LED battery indicator.
- Two button wireless control station to operate up to two doors.
- LED lighting rated to over 20 years of normal service. Automatically turns off 3 minutes after door closing.
- Convenient pull cord to disconnect the door drive allowing manual operation of the door in case of power cut. Optional external disconnect available.
- Soft-start and soft-close, automatic close (requires optional infra-red safety reverse system).
- Direct drive maintenance-free, 24 Volt DC, permanent lubrication motor gear.
- Safe - Optical detection of speed and door position. Automatically reverses upon meeting an obstruction.
- Secure - The opener acts as a positive lock on your door.



LiftMaster

DuraRoll Standard & DuraRoll Mini

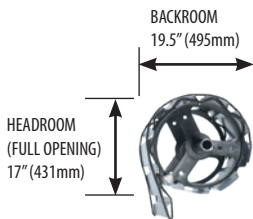
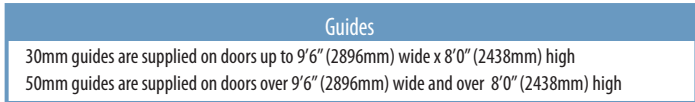
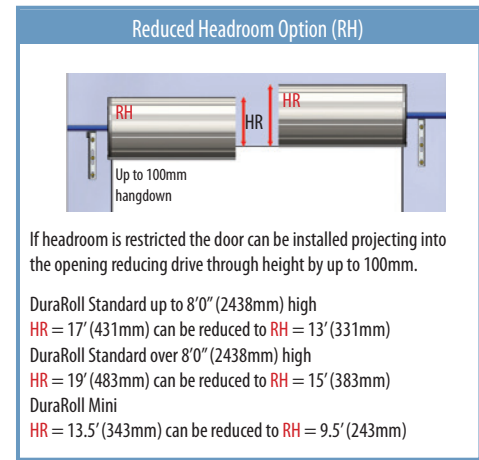
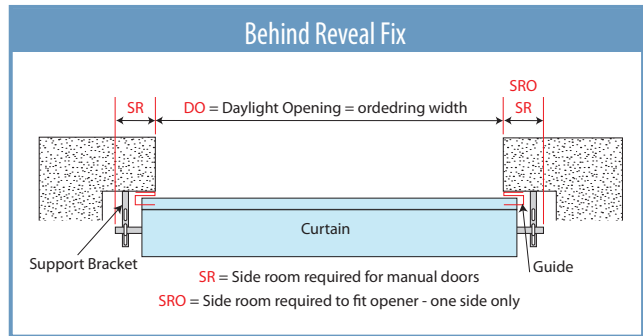
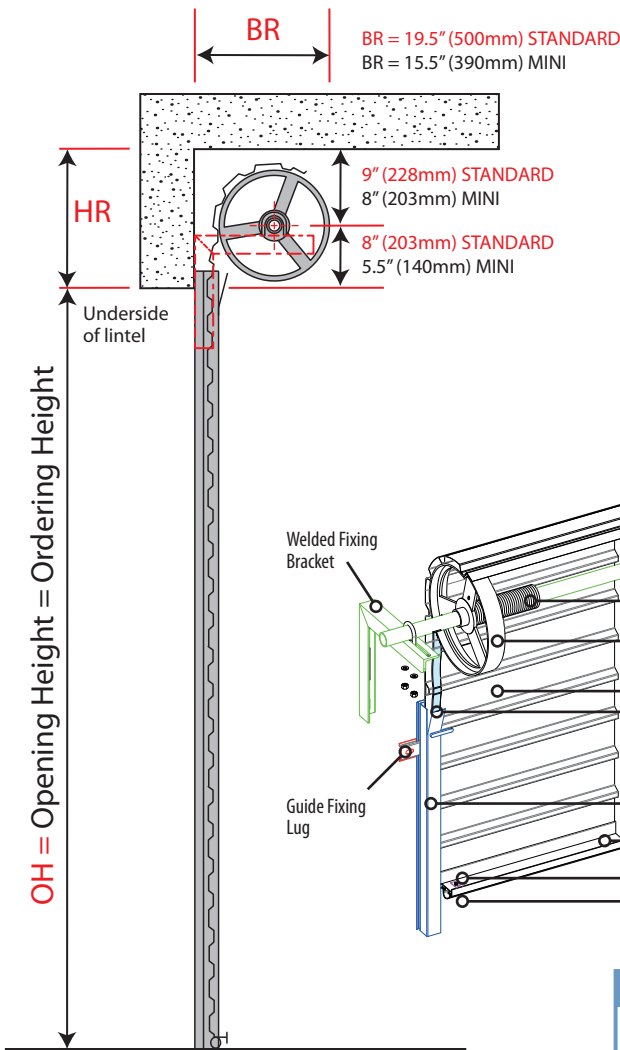

Standard DuraRoll - standard brackets 30mm guides

| HEADROOM | SIDEROOM WITHOUT OPENER | SIDEROOM WITH OPENER | BACKROOM |
|-------------|-------------------------|----------------------|---------------|
| HR | SR | SRO | BR |
| 17" (431mm) | 3.75" (95mm) | 5" (125mm) | 19.5" (495mm) |

On doors 8'-10' high a minimum of 19" (483mm) headroom is required.
Doors with 50mm guides require an additional 20mm sideroom.

Standard DuraRoll - notched brackets 30mm guides

| HEADROOM | SIDEROOM WITHOUT OPENER | SIDEROOM WITH OPENER | BACKROOM |
|-------------|-------------------------|----------------------|---------------|
| HR | SR | SRO | BR |
| 17" (431mm) | 3.00" (76mm) | 5" (125mm) | 19.5" (495mm) |

On doors 8'-10' high a minimum of 19" (483mm) headroom is required.
Doors with 50mm guides require an additional 20mm sideroom.

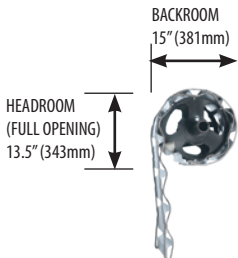

Mini DuraRoll - standard brackets 30mm guides

| HEADROOM | SIDEROOM WITHOUT OPENER | SIDEROOM WITH OPENER | BACKROOM |
|---------------|-------------------------|----------------------|-------------|
| HR | SR | SRO | BR |
| 13.5" (343mm) | 3.75" (95mm) | 6.75" (170mm) | 15" (381mm) |

DuraRoll Mini Roller is available up to 10' x 7' (3048 x 2134mm).
Doors with 50mm guides require an additional 20mm sideroom.

Mini DuraRoll - notched brackets 30mm guides

| HEADROOM | SIDEROOM WITHOUT OPENER | SIDEROOM WITH OPENER | BACKROOM |
|---------------|-------------------------|----------------------|-------------|
| HR | SR | SRO | BR |
| 13.5" (343mm) | 3.00" (76mm) | 6.75" (170mm) | 15" (381mm) |

DuraRoll Mini Roller is available up to 10' x 7' (3048 x 2134mm).
Doors with 50mm guides require an additional 20mm sideroom.

Floor rebate

To help assist water draining away effectively from the door and prevent water ingress you must have a rebate. If your floor is not rebated and not sloping away from the door you will be susceptible to water ingress as water will not be able to drain away effectively.

- **10mm minimum high rebate behind the door threshold or where your door seal meets a level floor.**
- **It must run 130mm past the opening to accommodate the guides**
- **It must run 130mm into the opening to accommodate the guides.**

